

# Ringschrauben - GK 10

## RSHVX M12 mit verschiedenen Gewindelängen

Ringschrauben • RSHVX • M12 • ohne Schlüssel • hochfest • variabel • orange lackiert • SI: 4

Artikel Nr.	Bezeichnung	Abm. mm	A mm	B mm	C mm	D mm	E mm	K mm	X mm	Gewicht Stk./kg
43.74.1.007.012.0220C	RSHVX 1222	M12x22	53,5	11	11	34	44	56	22	0,34
43.74.1.007.012.0270C	RSHVX 1227	M12x27	53,5	11	11	34	44	56	27	0,35
43.74.1.007.012.0320C	RSHVX 1232	M12x32	53,5	11	11	34	44	56	32	0,35
43.74.1.007.012.0370C	RSHVX 1237	M12x37	53,5	11	11	34	44	56	37	0,36
43.74.1.007.012.0420C	RSHVX 1242	M12x42	53,5	11	11	34	44	56	42	0,36
43.74.1.007.012.0470C	RSHVX 1247	M12x47	53,5	11	11	34	44	56	47	0,36
43.74.1.007.012.0520C	RSHVX 1252	M12x52	53,5	11	11	34	44	56	52	0,37
43.74.1.007.012.0570C	RSHVX 1257	M12x57	53,5	11	11	34	44	56	57	0,37
43.74.1.007.012.0620C	RSHVX 1262	M12x62	53,5	11	11	34	44	56	62	0,38
43.74.1.007.012.0670C	RSHVX 1267	M12x67	53,5	11	11	34	44	56	67	0,38
43.74.1.007.012.0720C	RSHVX 1272	M12x72	53,5	11	11	34	44	56	72	0,39
43.74.1.007.012.0770C	RSHVX 1277	M12x77	53,5	11	11	34	44	56	77	0,39
43.74.1.007.012.0820C	RSHVX 1282	M12x82	53,5	11	11	34	44	56	82	0,39
43.74.1.007.012.0920C	RSHVX 1292	M12x92	53,5	11	11	34	44	56	92	0,40
43.74.1.007.012.1020C	RSHVX 12102	M12x102	53,5	11	11	34	44	56	102	0,41
43.74.1.007.012.1120C	RSHVX 12112	M12x112	53,5	11	11	34	44	56	112	0,42
43.74.1.007.012.1220C	RSHVX 12122	M12x122	53,5	11	11	34	44	56	122	0,43
43.74.1.007.012.1320C	RSHVX 12132	M12x132	53,5	11	11	34	44	56	132	0,44
43.74.1.007.012.1420C	RSHVX 12142	M12x142	53,5	11	11	34	44	56	142	0,45
43.74.1.007.012.1520C	RSHVX 12152	M12x152	53,5	11	11	34	44	56	152	0,46
43.74.1.007.012.1720C	RSHVX 12172	M12x172	53,5	11	11	34	44	56	172	0,47

In Zugrichtungen einstellbar.





Mit verschiedenen Gewindelängen.

Für alle Ringschrauben kann ein handelsüblicher Imbusschlüssel verwendet werden.

# Ringschrauben - GK 10

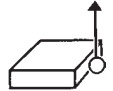
## RSHVX M12 mit verschiedenen Gewindelängen - Tragfähigkeitstabelle

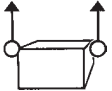
Tragfähigkeitstabelle • Ringschrauben • RSHVX • M12 • ohne Schlüssel • mit verschiedenen Gewindelängen

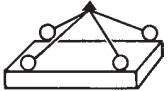
Anschlagart								
Stück	1	1	2	2	2	2	3 o. 4	3 o. 4
Neigungswinkel	0°	90°	0°	90°	0° - 45°	45° - 60°	0° - 45°	45° - 60°
Bezeichnung	Tragfähigkeit t							
RSHVX 1222 - RSHVX 12172	2	0,75	4	1,5	1	0,75	1,6	1,12

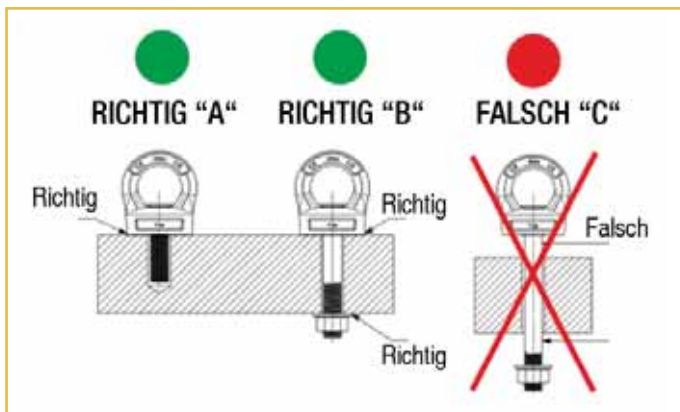
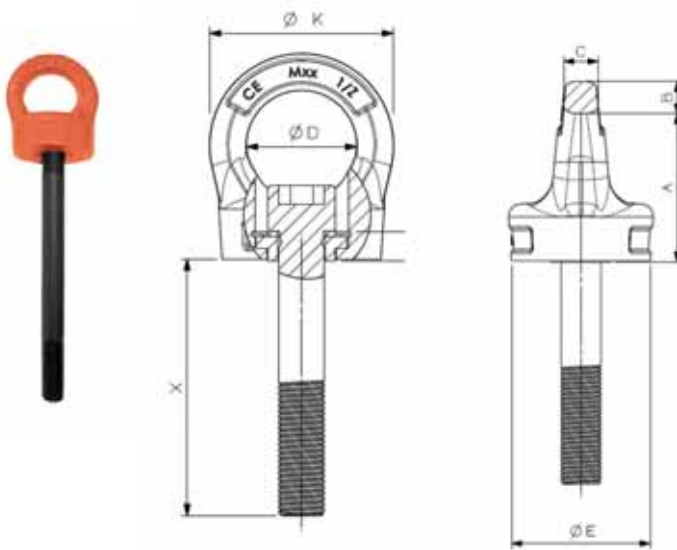

Geringfügige Maßabweichungen möglich.  
Andere Konstruktionen und Ausführungen auf Anfrage erhältlich!